

M&A PARTS INC.

AR15/M16 KITS, PARTS & ACCESSORIES

M14 PARTS / M1 GARAND PARTS / M2 CARBINE PARTS / 45 AUTO PARTS



M&A PARTS INC. / 527 Telser Road / Lake Zurich, IL 60047
Tel: 847-550-8246 / Fax: 847-550-0654 / www.m-aparts.com
Orders Only: 1-888-MNA-1516

M&A PARTS MANUFACTURING PROCESS

M&A Parts uses only the finest quality chrome moly and stainless steel blanks available to manufacture our barrels. We feel this is crucial; we won't sell out our customers or ourselves for \$20. We proudly use both Wilson Arms and Mike Rock Premium barrel blanks.

Our blanks are then sent to a current **Military Contractor** with 23 years of experience in the manufacturing of barrels, upper receivers, as well as numerous other components.

Once a barrel blank has reached the contractor it is rifled utilizing the "Button Broach" technique and forwarded to be "Stress Relieved". These procedures have been implemented to ensure that the most stringent specifications and guidelines are being met. The same meticulous care is given throughout the Chambering and Crowning processes to promote the finest accuracy and reliability. The barrels are then finished with a Magnesium Phosphate Coating adhering to Mil-Spec guidelines to prevent rust and corrosion. The highest measures of quality control are implemented to ensure no variance from barrel to barrel, or lot to lot.

The same contractor also manufactures our upper receivers, utilizing the same stringent guidelines to meet or exceed current Military Specifications. Our receivers are Hard Coat Black Anodized as per Mil-Spec.

In conclusion, all dimensional as well as assembling requirements are verified before each upper receiver is both function tested and test fired. All are then cleaned and oiled for preservation, and individually packaged.

M&A Parts, Inc. is committed to excellence. We look forward to meeting your needs for the highest quality and high value products. We set the standard that our competitors will follow.

**William R. Caplan, President
M&A Parts, Inc.**

TABLE OF CONTENTS

5.56 NATO AR-15/M16 Kits	Page 3 - 9
5.56 NATO Barreled Uppers	Page 10 - 15
7.62x39mm Kits	Page 16
7.62x39mm Barreled Uppers	Page 17
9mm Kits	Page 18
9mm Barreled Uppers	Page 19
Ordering Information and Order Form.	Page 20 - 21
FAL and UZI Kits	Page 22
Barrel Assembly Parts	Page 23
Barrel Assemblies	Page 24 - 25
Upper Receivers and Related Parts	Page 26 - 28
Bolt and Bolt Carrier Assembly Parts.	Page 27
Lower Receiver Parts	Page 28 - 29
AR Furniture and Related Items.	Page 30 - 33
Mags and Accessories	Page 34
Manuals and Bayonets	Page 35
Tools and More	Page 36
Scopes and Mounts	Page 37
M14 Parts and M1/M2 Carbine Parts	Page 38
M1 Garand Parts and 1911 .45 Auto Parts.	Page 39

VARMINT KITS - 5.56 NATO

All M&A Kits are complete, less stripped lower receiver, and come assembled, headspaced and test fired, direct from a current government contractor.



24" Varmint with Standard Barrel and optional Versa-Pod Bipod



24" Varmint with Fluted Barrel



20" Varmint with Standard Barrel



20" Varmint with Fluted Barrel



16" Varmint with Standard Barrel



16" Varmint with Fluted Barrel

Forged Flattop Upper Receiver
 Two Piece Aluminum Free Float Tube
 Match Grade Stainless Steel 1:8 Twist Varmint Barrel
 Barrel Diameter: .920" OD in front of gas block; 1.050" OD under handguard
 Picatinny Gas Block Front Sight Base - A2 Trapdoor Stock

24" Varmint Kit	Standard Barrel	\$510.00
24" Varmint Kit	Fluted Barrel	\$560.00
20" Varmint Kit	Standard Barrel	\$510.00
20" Varmint Kit	Fluted Barrel	\$560.00
16" Varmint Kit	Standard Barrel	\$510.00
16" Varmint Kit	Fluted Barrel	\$560.00

VARMINT KITS - OPTIONS AND UPGRADES

Substitute A2 Upper with NM Rear Sight	\$75.00	Add Removable Carry Handle	\$85.00
Substitute Chrome Bolt Carrier	\$25.00	Add Removable Front Sight	\$30.00
Substitute NM Two Stage Trigger	\$80.00	Add Versa-Pod Bipod	\$50.00
Substitute 20" or 24" 1:12 Twist Barrel	\$25.00			

24" E2 KITS - 5.56 NATO

All M&A Kits are complete, less stripped lower receiver, and come assembled, headspaced and test fired, direct from a current government contractor.

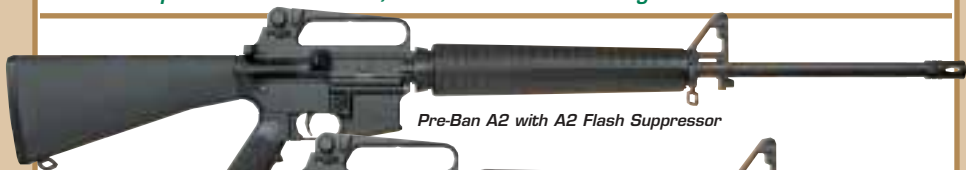

Pre-Ban A2 with A2 Flash Suppressor



Post-Ban Flattop with Press-on Mock Suppressor

Forged A2 Upper Receiver

Match Grade Chrome-Moly 1:9 Twist Heavy Barrel

E2 Handguards - Forged Front Sight Base - A2 Trapdoor Stock

Pre-Ban 24" E2 Kit A2 Upper, Bayonet Lug, A2 Flash Suppressor **\$425.00**

Post-Ban 24" E2 Kit A2 Upper, Press-on Mock Suppressor **\$425.00**



Pre-Ban Flattop with A2 Flash Suppressor



Post-Ban Flattop with Press-on Mock Suppressor

Forged Flattop Upper Receiver

Match Grade Chrome-Moly 1:9 Twist Heavy Barrel

E2 Handguards - Forged Front Sight Base - A2 Trapdoor Stock

Pre-Ban 24" E2 Kit Flattop Upper, Bayonet Lug, A2 Flash Suppressor **\$425.00**

Post-Ban 24" E2 Kit Flattop Upper, Press-on Mock Suppressor **\$425.00**

24" E2 KITS - OPTIONS AND UPGRADES

- | | | | |
|---|----------------|---|-----------------|
| Substitute Green Furniture | \$15.00 | Substitute DCM Free Float Handguard | \$100.00 |
| Substitute Picatinny Gas Block | \$25.00 | Add Barrel Fluting | \$50.00 |
| Substitute Chrome Bolt Carrier | \$25.00 | Add Removable Carry Handle | \$85.00 |
| Substitute NM Two Stage Trigger | \$80.00 | Add Removable Front Sight | \$30.00 |
| Substitute NM Rear Sight | \$25.00 | Add Versa-Pod Bipod | \$50.00 |
| Substitute Aluminum Free Float Tube | \$30.00 | | |

20" DCM NM KIT - 5.56 NATO



Forged A2 Upper Receiver with NM Rear Sight

Match Grade Stainless Steel 1:8 Twist Barrel

NM Two Stage Trigger - DCM Free Float Handguard System

Forged Front Sight Base - A2 Trapdoor Stock

Pre-Ban 20" DCM NM Kit Bayonet Lug, A2 Flash Suppressor **\$695.00**

Post-Ban 20" DCM NM Kit 11" Target Crown **\$695.00**

20" E2 KITS - 5.56 NATO

All M&A Kits are complete, less stripped lower receiver, and come assembled, headspaced and test fired, direct from a current government contractor.

Chrome-Moly



Post-Ban A2 with Press-on Mock Suppressor

Pre-Ban Flattop with A2 Flash Suppressor

Forged A2 or Flattop Upper Receiver

Match Grade Chrome-Moly 1:9 Twist Heavy Barrel

E2 Handguards - Forged Front Sight Base - A2 Trapdoor Stock

Pre-Ban 20" E2 Kit	A2 Upper, Bayonet Lug, A2 Flash Suppressor	\$425.00
Pre-Ban 20" E2 Kit	Flattop Upper, Bayonet Lug, A2 Flash Suppressor	\$425.00
Pre-Ban 20" E2 Kit	Chrome Lined 1:7 Twist A2 Barrel, Bayo Lug, A2 Suppressor	\$445.00
Post-Ban 20" E2 Kit	A2 Upper, Press-on Mock Suppressor	\$425.00
Post-Ban 20" E2 Kit	Flattop Upper, Press-on Mock Suppressor	\$425.00
Post-Ban 20" E2 Kit	A2 Upper, Permanent Muzzle Brake	\$465.00
Post-Ban 20" E2 Kit	Flattop Upper, Permanent Muzzle Brake	\$465.00

Stainless Steel



Pre-Ban A2 with A2 Flash Suppressor

Post-Ban Flattop with 11° Target Crown

Forged A2 or Flattop Upper Receiver

Match Grade Stainless Steel 1:8 Twist Heavy Barrel

E2 Handguards - Forged Front Sight Base - A2 Trapdoor Stock

Pre-Ban 20" E2 SST Kit	A2 Upper, Bayonet Lug, A2 Flash Suppressor	\$475.00
Pre-Ban 20" E2 SST Kit	Flattop Upper, Bayonet Lug, A2 Flash Suppressor	\$475.00
Post-Ban 20" E2 SST Kit	A2 Upper, 11° Target Crown	\$475.00
Post-Ban 20" E2 SST Kit	Flattop Upper, 11° Target Crown	\$475.00
Post-Ban 20" E2 SST Kit	A2 Upper, Permanent Muzzle Brake	\$515.00
Post-Ban 20" E2 SST Kit	Flattop Upper, Permanent Muzzle Brake	\$515.00

20" E2 KITS - OPTIONS AND UPGRADES

Substitute Green Furniture	\$15.00	Substitute DCM Free Float Handguard	\$100.00
Substitute Picatinny Gas Block	\$25.00	Add Barrel Fluting	\$50.00
Substitute Chrome Bolt Carrier	\$25.00	Add Removable Carry Handle	\$85.00
Substitute NM Two Stage Trigger	\$80.00	Add Removable Front Sight	\$30.00
Substitute NM Rear Sight	\$25.00	Add Versa-Pod Bipod	\$50.00
Substitute Aluminum Free Float Tube	\$30.00		

16" CAR KITS - 5.56 NATO

All M&A Kits are complete, less stripped lower receiver, and come assembled, headspaced and test fired, direct from a current government contractor.



Chrome-Moly

Pre-Ban A2 with A2 Suppressor

Post-Ban Flattop with Press-on Mock Suppressor

Forged A2 or Forged Flattop Upper Receiver
Match Grade Chrome-Moly 1:9 Twist Heavy Barrel
Pre-Ban: Collapsible CAR Stock; Post-Ban: Fixed CAR Stock
CAR Handguards with Heatshield - Forged Front Sight Base

Pre-Ban 16" CAR Kit	A2 Upper, Bayonet Lug, A2 Flash Suppressor	\$425.00
Pre-Ban 16" CAR Kit	Flattop Upper, Bayonet Lug, A2 Flash Suppressor	\$425.00
Post-Ban 16" CAR Kit	A2 Upper, Press-on Mock Suppressor	\$425.00
Post-Ban 16" CAR Kit	Flattop Upper, Press-on Mock Suppressor.	\$425.00
Post-Ban 16" CAR Kit	A2 Upper, Permanent Muzzle Brake	\$465.00
Post-Ban 16" CAR Kit	Flattop Upper, Permanent Muzzle Brake	\$465.00



Stainless Steel

Pre-Ban A2 with A2 Suppressor

Post-Ban Flattop with 11° Target Crown

Forged A2 or Forged Flattop Upper Receiver
Match Grade Stainless Steel 1:8 Twist Barrel
Pre-Ban: Collapsible CAR Stock; Post-Ban: Fixed CAR Stock
CAR Handguards with Heatshield - Forged Front Sight Base

Pre-Ban 16" SS CAR Kit	A2 Upper, Bayonet Lug, A2 Flash Suppressor	\$475.00
Pre-Ban 16" SS CAR Kit	Flattop Upper, Bayonet Lug, A2 Flash Suppressor	\$475.00
Post-Ban 16" SS CAR Kit	A2 Upper, 11° Target Crown	\$475.00
Post-Ban 16" SS CAR Kit	Flattop Upper, 11° Target Crown	\$475.00
Post-Ban 16" SS CAR Kit	A2 Upper, Permanent Muzzle Brake	\$515.00
Post-Ban 16" SS CAR Kit	Flattop Upper, Permanent Muzzle Brake	\$515.00

16" CAR KITS - OPTIONS AND UPGRADES

Substitute A2 Trapdoor Buttstock	No Charge	Substitute Chrome Bolt Carrier	\$25.00
Substitute Fixed Shorty Buttstock	No Charge	Substitute NM Two Stage Trigger	\$80.00
Substitute Aluminum CAR Stock	\$30.00	Substitute Aluminum Free Float Tube	\$30.00
Substitute M4 Tactical Stock	\$30.00	Add Barrel Fluting	\$50.00
Substitute Green Furniture	\$15.00	Add Removable Carry Handle	\$85.00
Substitute Picatinny Gas Block	\$25.00	Add Removable Front Sight	\$30.00

16" MID-LENGTH KITS - 5.56 NATO

All M&A Kits are complete, less stripped lower receiver, and come assembled, headspaced and test fired, direct from a current government contractor.



Chrome-Moly

Pre-Ban A2 with A2 Flash Suppressor

Post-Ban Flattop with Permanent Muzzle Brake

Optional A2 Stock

Forged A2 or Forged Flattop Upper Receiver
Match Grade Chrome-Moly 1:9 Twist Heavy Barrel
Pre-Ban: Collapsible CAR Stock; Post-Ban: Fixed CAR Stock
Mid-Length Handguards w/Heatshield - Forged Front Sight Base

- | | | |
|------------------------------------|---|-----------------|
| Pre-Ban 16" Mid-length Kit | A2 Upper, Bayonet Lug, A2 Flash Suppressor . . . | \$450.00 |
| Pre-Ban 16" Mid-length Kit | Flattop Upper, Bayonet Lug, A2 Suppressor | \$450.00 |
| Post-Ban 16" Mid-length Kit | A2 Upper, 11° Target Crown | \$450.00 |
| Post-Ban 16" Mid-length Kit | Flattop Upper, 11° Target Crown | \$450.00 |
| Post-Ban 16" Mid-length Kit | A2 Upper, Permanent Muzzle Brake | \$490.00 |
| Post-Ban 16" Mid-length Kit | Flattop Upper, Permanent Muzzle Brake | \$490.00 |



Stainless Steel

Pre-Ban A2 with A2 Suppressor

Post-Ban Flattop with 11° Target Crown

Forged A2 or Forged Flattop Upper Receiver
Match Grade Stainless Steel 1:8 Twist Barrel
Pre-Ban: Collapsible CAR Stock; Post-Ban: Fixed CAR Stock
CAR Handguards with Heatshield - Forged Front Sight Base

- | | | |
|---------------------------------------|---|-----------------|
| Pre-Ban 16" SS Mid-length Kit | A2 Upper, Bayonet Lug, A2 Suppressor | \$500.00 |
| Pre-Ban 16" SS Mid-length Kit | Flattop Upper, Bayonet Lug, A2 Suppressor | \$500.00 |
| Post-Ban 16" SS Mid-length Kit | A2 Upper, 11° Target Crown | \$500.00 |
| Post-Ban 16" SS Mid-length Kit | Flattop Upper, 11° Target Crown | \$500.00 |
| Post-Ban 16" SS Mid-length Kit | A2 Upper, Permanent Muzzle Brake | \$540.00 |
| Post-Ban 16" SS Mid-length Kit | Flattop Upper, Permanent Muzzle Brake | \$540.00 |

16" MID-LENGTH KITS - OPTIONS AND UPGRADES

- | | | | |
|---|------------------|---|----------------|
| Substitute A2 Trapdoor Buttstock | No Charge | Substitute Chrome Bolt Carrier | \$25.00 |
| Substitute Fixed Shorty Buttstock | No Charge | Substitute NM Two Stage Trigger | \$80.00 |
| Substitute Aluminum CAR Stock | \$30.00 | Substitute Aluminum Free Float Tube | \$40.00 |
| Substitute M4 Tactical Stock | \$30.00 | Add Barrel Fluting | \$50.00 |
| Substitute Green Furniture | \$15.00 | Add Removable Carry Handle | \$85.00 |
| Substitute Picatinny Gas Block | \$25.00 | Add Removable Front Sight | \$30.00 |

CARBINE KITS - 5.56 NATO

All M&A Kits are complete, less stripped lower receiver, and come assembled, headspaced and test fired, direct from a current government contractor.

Optional M4
Tactical Stock



M16 only, 14.5" A2 with A2 Suppressor

M4 Style



Post-Ban Flattop with
Press-on Mock Suppressor

Forged A2 or Forged Flattop Upper Receiver
Match Grade Chrome-Moly 1:9 Twist M4 Barrel
Pre-Ban: Collapsible CAR Stock; Post-Ban: Fixed CAR Stock
M4 Style Handguards w/Heatshield - Forged Front Sight Base

- M16 only, 14.5" M4 Kit** A2 Upper, Bayonet Lug, A2 Flash Suppressor **\$475.00**
- M16 only, 14.5" M4 Kit** Flattop Upper, Bayonet Lug, A2 Flash Suppressor **\$475.00**
- Pre-Ban 16" M4 Kit** A2 Upper, Bayonet Lug, A2 Flash Suppressor **\$475.00**
- Pre-Ban 16" M4 Kit** Flattop Upper, Bayonet Lug, A2 Flash Suppressor **\$475.00**
- Post-Ban 16" M4 Kit** A2 Upper, Press-on Mock Suppressor **\$475.00**
- Post-Ban 16" M4 Kit** Flattop Upper, Press-on Mock Suppressor **\$475.00**
- Post-Ban 16" M4 Kit** A2 Upper, Permanent Muzzle Brake **\$515.00**
- Post-Ban 16" M4 Kit** Flattop Upper, Permanent Muzzle Brake **\$515.00**



Pre-Ban A2 with A2 Flash Suppressor

Lightweight



Post-Ban Flattop with 11° Target Crown

Optional Fixed
Shorty Stock

Forged A2 or Forged Flattop Upper Receiver
Match Chrome-Moly 1:9 Twist Lightweight Barrel
Pre-Ban: Collapsible CAR Stock; Post-Ban: Fixed CAR Stock
CAR Handguards with Heatshield - Forged Front Sight Base

- Pre-Ban 16" Lightweight Kit** A2 Upper, Bayonet Lug, A2 Flash Suppressor **\$450.00**
- Pre-Ban 16" Lightweight Kit** Flattop Upper, Bayonet Lug, A2 Suppressor **\$450.00**
- Post-Ban 16" Lightweight Kit** A2 Upper, 11° Target Crown **\$450.00**
- Post-Ban 16" Lightweight Kit** Flattop Upper, 11° Target Crown **\$450.00**

M4 / LIGHTWEIGHT KITS - OPTIONS AND UPGRADES

- | | |
|--|--|
| Substitute A2 Trapdoor Buttstock No Charge | Substitute Chrome Bolt Carrier \$25.00 |
| Substitute Fixed Shorty Buttstock No Charge | Substitute NM Two Stage Trigger \$80.00 |
| Substitute Aluminum CAR Stock \$30.00 | Add Removable Carry Handle \$85.00 |
| Substitute M4 Tactical Stock \$30.00 | Add Removable Front Sight \$30.00 |
| Substitute Green Furniture \$15.00 | Add G.I. Side Sling Adapter \$30.00 |

CARBINE KITS - 5.56 NATO

All M&A Kits are complete, less stripped lower receiver, and come assembled, headspaced and test fired, direct from a current government contractor.



Pre-Ban A2 with Permanent 5.5" Flash Hider

XM Style



Pre-Ban Flattop with Permanent 5.5" Flash Hider

Forged A2 or Forged Flattop Upper Receiver
Match Grade Chrome-Moly 1:9 Twist Heavy Barrel
11.5" Barrel with 5.5" Permanently Attached Flash Hider
Collapsible CAR Stock - CAR Handguards with Heatshield - Forged Front Sight Base

Pre-Ban 16" XM Kit A2 Upper, Bayonet Lug, 5.5" Flash Hider **\$460.00**
Pre-Ban 16" XM Kit Flattop Upper, Bayonet Lug, 5.5" Flash Hider **\$460.00**

XM KITS - OPTIONS AND UPGRADES

Substitute A2 Trapdoor Buttstock	No Charge	Substitute Green Furniture	\$15.00
Substitute Fixed Shorty Buttstock	No Charge	Substitute Chrome Bolt Carrier	\$25.00
Substitute Aluminum CAR Stock	\$30.00	Substitute NM Two Stage Trigger	\$80.00
Substitute M4 Tactical Stock	\$30.00	Add Removable Carry Handle	\$85.00

COMMANDO KITS - 5.56 NATO



M16 only, 10.25" A2 with A2 Flash Suppressor



M16 only, 11.5" Flattop with A2 Flash Suppressor

Forged A2 or Forged Flattop Upper Receiver
Match Grade Chrome-Moly 1:9 Twist Heavy Barrel
Collapsible CAR Stock - CAR Handguards with Heatshield - Forged Front Sight Base

M16 only, 10.25" Commando Kit A2 Upper, Bayonet Lug, A2 Suppressor . . **\$425.00**
M16 only, 10.25" Commando Kit Flattop, Bayonet Lug, A2 Suppressor . . . **\$425.00**
M16 only, 11.5" Commando Kit A2 Upper, Bayonet Lug, A2 Suppressor . . . **\$425.00**
M16 only, 11.5" Commando Kit Flattop, Bayonet Lug, A2 Suppressor. . . . **\$425.00**

COMMANDO KITS - OPTIONS AND UPGRADES

Substitute A2 Trapdoor Buttstock	No Charge	Substitute Green Furniture	\$15.00
Substitute Fixed Shorty Buttstock	No Charge	Substitute Chrome Bolt Carrier	\$25.00
Substitute Aluminum CAR Stock	\$30.00	Substitute NM Two Stage Trigger	\$80.00
Substitute M4 Tactical Stock	\$30.00	Add Removable Carry Handle	\$85.00

VARMINT BARRELED UPPERS - 5.56 NATO

All M&A Barreled Upper Assemblies come assembled and headspaced.



Forged Flattop Upper Receiver - Stainless Steel 1:8 Twist Varmint Barrel
Two Piece Aluminum Free Float Tube - Picatinny Gas Block Front Sight Base

24" Varmint	Standard Barrel	\$340.00
24" Varmint	Fluted Barrel	\$390.00
20" Varmint	Standard Barrel	\$340.00
20" Varmint	Fluted Barrel	\$390.00
16" Varmint	Standard Barrel	\$340.00
16" Varmint	Fluted Barrel	\$390.00

VARMINT BARRELED UPPERS - OPTIONS AND UPGRADES

Add Bolt Carrier Assembly & Charging Handle	\$90.00	Add Versa-Pod Bipod	\$50.00
Add Removable Carry Handle	\$85.00	Substitute 20" or 24" 1:12 Twist Barrel	\$25.00
Add Removable Front Sight	\$30.00		

DCM NM BARRELED UPPERS - 5.56 NATO



Forged A2 Upper Receiver with NM Rear Sight - Forged Front Sight Base
Match Grade Stainless Steel 1:8 Twist Barrel - DCM Free Float Handguard System

Pre-Ban 20" DCM NM	Bayonet Lug, A2 Flash Suppressor	\$485.00
Post-Ban 20" DCM NM	11° Target Crown	\$485.00
Add Bolt Carrier Assembly and Charging Handle		\$90.00

E2 BARRELED UPPERS - 5.56 NATO

All M&A Barreled Upper Assemblies come assembled and headspaced.

24" E2

Pre-Ban A2,
A2 Flash
Suppressor

Chrome-Moly



Forged A2 or Forged Flattop Upper Receiver - Forged Front Sight Base
Match Grade Chrome-Moly 1:9 Twist Heavy Barrel - E2 Handguards

Pre-Ban 24" E2 A2 Upper, Bayonet Lug, A2 Flash Suppressor	\$295.00
Pre-Ban 24" E2 Flattop Upper, Bayonet Lug, A2 Flash Suppressor	\$295.00
Post-Ban 24" E2 A2 Upper, Press-on Mock Suppressor	\$295.00
Post-Ban 24" E2 Flattop Upper, Press-on Mock Suppressor	\$295.00

20" E2

Pre-Ban A2,
A2 Flash
Suppressor

Chrome-Moly



Post-Ban Flattop,
Mock Suppressor



Forged A2 or Forged Flattop Upper Receiver - Forged Front Sight Base
Match Grade Chrome-Moly 1:9 Twist Heavy Barrel - E2 Handguards

Pre-Ban 20" E2 A2 Upper, Bayonet Lug, A2 Flash Suppressor	\$295.00
Pre-Ban 20" E2 Flattop Upper, Bayonet Lug, A2 Flash Suppressor	\$295.00
Post-Ban 20" E2 A2 Upper, Press-on Mock Suppressor	\$295.00
Post-Ban 20" E2 Flattop Upper, Press-on Mock Suppressor	\$295.00
Post-Ban 20" E2 A2 Upper, Permanent Muzzle Brake	\$335.00
Post-Ban 20" E2 Flattop Upper, Permanent Muzzle Brake	\$335.00

20" E2

Pre-Ban A2,
A2 Flash Suppressor

Stainless Steel



Post-Ban Flattop,
11° Target Crown, with
optional Picatinny Gas Block



Forged A2 or Forged Flattop Upper Receiver - Forged Front Sight Base
Match Grade Stainless Steel 1:8 Twist Heavy Barrel - E2 Handguards

Pre-Ban 20" E2 SST Kit A2 Upper, Bayonet Lug, A2 Flash Suppressor	\$345.00
Pre-Ban 20" E2 SST Kit Flattop Upper, Bayonet Lug, A2 Flash Suppressor	\$345.00
Post-Ban 20" E2 SST Kit A2 Upper, 11° Target Crown	\$345.00
Post-Ban 20" E2 SST Kit Flattop Upper, 11° Target Crown	\$345.00
Post-Ban 20" E2 SST Kit A2 Upper, Permanent Muzzle Brake	\$385.00
Post-Ban 20" E2 SST Kit Flattop Upper, Permanent Muzzle Brake	\$385.00

E2 BARRELED UPPERS - OPTIONS AND UPGRADES

Add Bolt Carrier Assembly & Charging Handle	\$90.00	Add Barrel Fluting	\$50.00
Substitute Green Handguards	\$5.00	Add Removable Carry Handle	\$85.00
Substitute Aluminum Free Float Tube	\$30.00	Add Removable Front Sight	\$30.00
Substitute Picatinny Gas Block	\$25.00	Add NM Rear Sight	\$25.00

CAR BARRELED UPPERS - 5.56 NATO

All M&A Barreled Upper Assemblies come assembled and headspaced.

Chrome-Moly

*Pre-Ban A2,
A2 Flash Suppressor*



*Post-Ban Flattop,
Permanent Brake*



*Post-Ban A2, Optional Fluted Barrel,
Press-on Mock Suppressor*



Forged A2 or Forged Flattop Upper Receiver - Forged Front Sight Base

Match Grade Chrome-Moly 1:9 Twist Heavy Barrel - CAR Handguards with Heatshield

Pre-Ban 16" CAR	A2 Upper, Bayonet Lug, A2 Flash Suppressor	\$295.00
Pre-Ban 16" CAR	Flattop Upper, Bayonet Lug, A2 Flash Suppressor	\$295.00
Post-Ban 16" CAR	A2 Upper, Press-on Mock Suppressor	\$295.00
Post-Ban 16" CAR	Flattop Upper, Press-on Mock Suppressor	\$295.00
Post-Ban 16" CAR	A2 Upper, Permanent Muzzle Brake	\$335.00
Post-Ban 16" CAR	Flattop Upper, Permanent Muzzle Brake	\$335.00

Stainless Steel

*Pre-Ban Flattop,
A2 Suppressor*



*Post-Ban A2,
11° Target Crown*



*Post-Ban Flattop,
Permanent Brake*



Forged A2 or Forged Flattop Upper Receiver - Forged Front Sight Base

Match Grade Stainless Steel 1:8 Twist Barrel - CAR Handguards with Heatshield

Pre-Ban 16" SS CAR	A2 Upper, Bayonet Lug, A2 Flash Suppressor	\$345.00
Pre-Ban 16" SS CAR	Flattop Upper, Bayonet Lug, A2 Flash Suppressor	\$345.00
Post-Ban 16" SS CAR	A2 Upper, 11° Target Crown	\$345.00
Post-Ban 16" SS CAR	Flattop Upper, 11° Target Crown	\$345.00
Post-Ban 16" SS CAR	A2 Upper, Permanent Muzzle Brake	\$385.00
Post-Ban 16" SS CAR	Flattop Upper, Permanent Muzzle Brake	\$385.00

16" CAR BARRELED UPPERS - OPTIONS AND UPGRADES

Add Bolt Carrier Assembly & Charging Handle	\$90.00	Substitute Aluminum Free Float Tube	\$30.00
Substitute Green Handguards	\$5.00	Add Barrel Fluting	\$50.00
Substitute M4 Style Handguards	\$15.00	Add Removable Carry Handle	\$85.00
Substitute Picatinny Gas Block	\$25.00	Add Removable Front Sight	\$30.00

MID-LENGTH BARRELED UPPERS - 5.56 NATO

All M&A Barreled Upper Assemblies come assembled and headspaced.

Chrome-Moly

Pre-Ban A2,
A2 Flash
Suppressor



Post-Ban Flattop,
11° Target Crown



Post-Ban A2,
Permanent Brake



Forged A2 or Forged Flattop Upper Receiver - Forged Front Sight Base

Match Chrome-Moly 1:9 Twist Heavy Barrel - Mid-Length Handguards w/Heatshield

Pre-Ban 16" Mid-Length	A2 Upper, Bayonet Lug, A2 Flash Suppressor	\$320.00
Pre-Ban 16" Mid-Length	Flattop Upper, Bayonet Lug, A2 Flash Suppressor	\$320.00
Post-Ban 16" Mid-Length	A2 Upper, 11° Target Crown	\$320.00
Post-Ban 16" Mid-Length	Flattop Upper, 11° Target Crown	\$320.00
Post-Ban 16" Mid-Length	A2 Upper, Permanent Muzzle Brake	\$360.00
Post-Ban 16" Mid-Length	Flattop Upper, Permanent Muzzle Brake	\$360.00

Stainless Steel

Pre-Ban Flattop, A2 Suppressor



Post-Ban A2,
11° Target Crown



Post-Ban Flattop,
Permanent Brake



Forged A2 or Forged Flattop Upper Receiver - Forged Front Sight Base

Match Grade Stainless Steel 1:8 Twist Barrel - CAR Handguards with Heatshield

Pre-Ban 16" SS Mid-Length	A2 Upper, Bayonet Lug, A2 Flash Suppressor	\$370.00
Pre-Ban 16" SS Mid-Length	Flattop Upper, Bayonet Lug, A2 Suppressor	\$370.00
Post-Ban 16" SS Mid-Length	A2 Upper	\$370.00
Post-Ban 16" SS Mid-Length	Flattop Upper	\$370.00
Post-Ban 16" SS Mid-Length	A2 Upper, Permanent Muzzle Brake	\$410.00
Post-Ban 16" SS Mid-Length	Flattop Upper, Permanent Muzzle Brake	\$410.00

16" MID-LENGTH BARRELED UPPERS - OPTIONS AND UPGRADES

Add Bolt Carrier Assembly & Charging Handle	\$90.00	Add Barrel Fluting	\$50.00
Substitute Green Handguards	\$5.00	Add Removable Carry Handle	\$85.00
Substitute Picatinny Gas Block	\$25.00	Add Removable Front Sight	\$30.00
Substitute Aluminum Free Float Tube	\$40.00		

CARBINE BARRELED UPPERS - 5.56 NATO

All M&A Barreled Upper Assemblies come assembled and headspaced.

M4 Style



Forged A2 or Forged Flattop Upper Receiver - Forged Front Sight Base

Match Grade Chrome-Moly 1:9 Twist M4 Barrel - M4 Style Handguards w/Heatshield

M16 only, 14.5" M4	A2 Upper, Bayonet Lug, A2 Flash Suppressor	\$345.00
M16 only, 14.5" M4	Flattop Upper, Bayonet Lug, A2 Flash Suppressor	\$345.00
Pre-Ban 16" M4	A2 Upper, Bayonet Lug, A2 Flash Suppressor	\$345.00
Pre-Ban 16" M4	Flattop Upper, Bayonet Lug, A2 Flash Suppressor	\$345.00
Post-Ban 16" M4	A2 Upper, Press-on Mock Suppressor	\$345.00
Post-Ban 16" M4	Flattop Upper, Press-on Mock Suppressor	\$345.00
Post-Ban 16" M4	A2 Upper, Permanent Muzzle Brake	\$385.00
Post-Ban 16" M4	Flattop Upper, Permanent Muzzle Brake	\$385.00

Lightweight



Forged A2 or Forged Flattop Upper Receiver - Forged Front Sight Base

Match Chrome-Moly 1:9 Twist Lightweight Barrel - CAR Handguards with Heatshield

Pre-Ban 16" Lightweight	A2 Upper, Bayonet Lug, A2 Flash Suppressor	\$320.00
Pre-Ban 16" Lightweight	Flattop Upper, Bayonet Lug, A2 Suppressor	\$320.00
Post-Ban 16" Lightweight	A2 Upper, 11° Target Crown	\$320.00
Post-Ban 16" Lightweight	Flattop Upper, 11° Target Crown	\$320.00

M4 / LIGHTWEIGHT UPPERS - OPTIONS AND UPGRADES

Add Bolt Carrier Assembly & Charging Handle	\$90.00	Add Removable Carry Handle	\$85.00
Substitute Green Handguards	\$5.00	Add G.I. Side Sling Adapter	\$30.00

CARBINE BARRELED UPPERS - 5.56 NATO

All M&A Barreled Upper Assemblies come assembled and headspaced.

XM Style

*Pre-Ban A2,
5.5" Flash Hider*



*Pre-Ban Flattop,
5.5" Flash Hider*



Forged A2 or Forged Flattop Upper Receiver - Forged Front Sight Base
11.5" Match Grade Chrome-Moly 1:9 Twist Heavy Barrel
5.5" Permanently Attached Flash Hider - CAR Handguards with Heatshield

- Pre-Ban 16" XM Style** A2 Upper, Bayonet Lug, 5.5" Flash Hider **\$330.00**
Pre-Ban 16" XM Style Flattop Upper, Bayonet Lug, 5.5" Flash Hider **\$330.00**

XM BARRELED UPPERS - OPTIONS AND UPGRADES

- Add Bolt Carrier Assembly & Charging Handle **\$90.00** | Substitute M4 Style Handguards **\$15.00**
 Substitute Green Handguards **\$5.00** | Add Removable Carry Handle **\$85.00**

COMMANDO BARRELED UPPERS - 5.56 NATO

*M16 only, 10.25" A2,
A2 Flash Suppressor*



*M16 only,
10.25" Flattop,
A2 Flash Suppressor*



*M16 only, 11.5" A2,
A2 Flash Suppressor*



*M16 only,
11.5" Flattop,
A2 Flash Suppressor*



Forged A2 or Forged Flattop Upper Receiver - Forged Front Sight Base
Match Grade Chrome-Moly 1:9 Twist Heavy Barrel - CAR Handguards with Heatshield

- M16 only, 10.25" Commando** A2 Upper, Bayonet Lug, A2 Suppressor **\$295.00**
M16 only, 10.25" Commando Flattop Upper, Bayonet Lug, A2 Suppressor **\$295.00**
M16 only, 11.5" Commando A2 Upper, Bayonet Lug, A2 Suppressor **\$295.00**
M16 only, 11.5" Commando Flattop Upper, Bayonet Lug, A2 Suppressor **\$295.00**

COMMANDO BARRELED UPPERS - OPTIONS AND UPGRADES

- Add Bolt Carrier Assembly & Charging Handle **\$90.00** | Substitute M4 Style Handguards **\$15.00**
 Substitute Green Handguards **\$5.00** | Add Removable Carry Handle **\$85.00**

7.62x39mm KITS

All M&A Kits are complete, less stripped lower receiver, and come assembled, headspaced and test fired, direct from a current government contractor.

7.62x39mm



E2 Kits

Post-Ban A2 with Press-on Mock Suppressor

Forged A2 or Forged Flattop Upper Receiver
Match Grade Chrome-Moly 1:10 Twist Heavy Barrel

E2 Handguards - Forged Front Sight Base - A2 Trapdoor Stock - Includes 1 Ten Round Mag

Pre-Ban 20" E2 Kit A2 Upper, Bayonet Lug, A2 Flash Suppressor **\$485.00**

Pre-Ban 20" E2 Kit Flattop Upper, Bayonet Lug, A2 Flash Suppressor **\$485.00**

Post-Ban 20" E2 Kit A2 Upper, Press-on Mock Suppressor **\$485.00**

Post-Ban 20" E2 Kit Flattop Upper, Press-on Mock Suppressor **\$485.00**

Optional Tactical CAR Stock

7.62x39mm

CAR Kits



Pre-Ban A2 with A2 Flash Suppressor

Post-Ban Flattop with Press-On Mock Suppressor

Forged A2 or Forged Flattop Upper Receiver
Match Grade Chrome-Moly 1:10 Twist Heavy Barrel

Pre-Ban: Collapsible CAR Stock; Post-Ban: Fixed CAR Stock

CAR Handguards with Heatshield - Forged Front Sight Base - Includes 1 Ten Round Magazine

Pre-Ban 16" CAR Kit A2 Upper, Bayonet Lug, A2 Flash Suppressor **\$485.00**

Pre-Ban 16" CAR Kit Flattop Upper, Bayonet Lug, A2 Flash Suppressor **\$485.00**

Post-Ban 16" CAR Kit A2 Upper, Press-on Mock Suppressor **\$485.00**

Post-Ban 16" CAR Kit Flattop Upper, Press-on Mock Suppressor. **\$485.00**

7.62x39mm



Commando Kits

M16 only, 11.5" A2 with A2 Flash Suppressor

Forged A2 or Forged Flattop Upper Receiver
Match Grade Chrome-Moly 1:10 Twist Heavy Barrel

Collapsible CAR Stock - CAR Handguards with Heatshield

Forged Front Sight Base - Includes 1 Ten Round Magazine

M16 only, 11.5" Commando Kit A2 Upper, Bayonet Lug, A2 Suppressor. **\$485.00**

M16 only, 11.5" Commando Kit Flattop, Bayonet Lug, A2 Suppressor. **\$485.00**

7.62x39mm KITS - OPTIONS AND UPGRADES

Substitute A2 Trapdoor Buttstock	No Charge	Substitute Green Furniture	\$15.00
Substitute Fixed Shorty Buttstock	No Charge	Add Removable Carry Handle	\$85.00
Substitute Aluminum CAR Stock	\$30.00	Add Versa-Pod Bipod.	\$50.00
Substitute M4 Tactical Stock	\$30.00	Additional 10 Round Mags	\$20.00

7.62x39mm BARRELED UPPERS

All M&A Barreled Upper Assemblies come assembled and headspaced.

20" E2

7.62x39mm



Forged A2 or Forged Flattop Upper Receiver - Forged Front Sight Base
Match Grade Chrome-Moly 1:10 Twist Heavy Barrel - E2 Handguards

Pre-Ban 20" E2 A2 Upper, Bayonet Lug, A2 Flash Suppressor	\$330.00
Pre-Ban 20" E2 Flattop Upper, Bayonet Lug, A2 Flash Suppressor	\$330.00
Post-Ban 20" E2 A2 Upper, Press-on Mock Suppressor	\$330.00
Post-Ban 20" E2 Flattop Upper, Press-on Mock Suppressor	\$330.00

16" CAR

7.62x39mm



Forged A2 or Forged Flattop Upper Receiver - Forged Front Sight Base
Match Grade Chrome-Moly 1:10 Twist Heavy Barrel - CAR Handguards with Heatshield

Pre-Ban 16" CAR A2 Upper, Bayonet Lug, A2 Flash Suppressor	\$330.00
Pre-Ban 16" CAR Flattop Upper, Bayonet Lug, A2 Flash Suppressor	\$330.00
Post-Ban 16" CAR A2 Upper, Press-on Mock Suppressor	\$330.00
Post-Ban 16" CAR Flattop Upper, Press-on Mock Suppressor	\$330.00

11.5" Commando

7.62x39mm



Forged A2 or Forged Flattop Upper Receiver - Forged Front Sight Base
Match Grade Chrome-Moly 1:10 Twist Heavy Barrel - CAR Handguards with Heatshield

M16 only, 11.5" Commando A2 Upper, Bayonet Lug, A2 Suppressor	\$330.00
M16 only, 11.5" Commando Flattop Upper, Bayonet Lug, A2 Suppressor	\$330.00

7.62x39mm BARRELED UPPERS - OPTIONS AND UPGRADES

Add Bolt Carrier Assembly & Charging Handle	\$105.00	Add Removable Carry Handle	\$85.00
Substitute Green Handguards	\$5.00	Add Versa-Pod Bipod	\$50.00
Substitute Aluminum Free Float Tube	\$30.00	Add 10 Round Magazine	\$20.00

9MM COMPLETE KITS

All M&A 9mm Kits are complete, less stripped lower receiver, and include the Magwell conversion block. They come assembled, headspaced and test fired.



9mm 16" CAR

Pre-Ban A2 with
A2 Flash Suppressor

Post-Ban Flattop with 11° Target Crown

Forged A2 or Forged Flattop Upper Receiver
Match Grade Chrome-Moly 1:10 Twist Heavy Barrel
Pre-Ban: Collapsible CAR Stock; Post-Ban: Fixed CAR Stock

CAR Handguards with Heatshield - Forged Front Sight Base - Includes 1 Magazine

- 9mm Pre-Ban 16" CAR Kit** A2 Upper, Bayonet Lug, A2 Flash Suppressor . . . **\$745.00**
- 9mm Pre-Ban 16" CAR Kit** Flattop Upper, Bayonet Lug, A2 Flash Suppressor **\$745.00**
- 9mm Post-Ban 16" CAR Kit** A2 Upper, 11° Target Crown **\$745.00**
- 9mm Post-Ban 16" CAR Kit** Flattop Upper, 11° Target Crown **\$745.00**
- 9mm Post-Ban 16" CAR Kit** A2 Upper, Permanent Muzzle Brake **\$785.00**
- 9mm Post-Ban 16" CAR Kit** Flattop Upper, Permanent Muzzle Brake **\$785.00**

9mm Conversion Kit As above, but without lower receiver parts and without buttstock assembly **\$675.00**

9mm 16" CAR KITS - OPTIONS AND UPGRADES

- | | | | |
|---|------------------|---|------------------|
| Substitute A2 Trapdoor Buttstock | No Charge | Substitute Mid-Length Handguard | No Charge |
| Substitute Fixed Shorty Buttstock | No Charge | Substitute CAR Aluminum Free Float Tube | \$30.00 |
| Substitute Aluminum CAR Stock | \$30.00 | Substitute Mid-Length Aluminum Free Float | \$40.00 |
| Substitute M4 Tactical Stock | \$30.00 | Substitute Picatinny Gas Block | \$25.00 |
| Substitute Green Furniture | \$15.00 | Add Removable Carry Handle | \$85.00 |
| Substitute M4 Style Handguard | \$15.00 | Add Magazine | \$35.00 |



9mm 11.5" Commando

M16 only, A2 with
A2 Flash Suppressor

M16 only, Flattop with A2 Flash Suppressor

Forged A2 or Forged Flattop Upper Receiver
Match Grade Chrome-Moly 1:10 Twist Heavy Barrel
Collapsible CAR Stock - CAR Handguards with Heatshield
Forged Front Sight Base - Includes 1 Magazine

- M16 only, 9mm 11.5" Kit** A2 Upper, Bayonet Lug, A2 Flash Suppressor . . . **\$745.00**
- M16 only, 9mm 11.5" Kit** Flattop Upper, Bayonet Lug, A2 Flash Suppressor **\$745.00**

9mm 11.5" COMMANDO KITS - OPTIONS AND UPGRADES

- | | | | |
|---|------------------|---|----------------|
| Substitute A2 Trapdoor Buttstock | No Charge | Substitute Green Furniture | \$15.00 |
| Substitute Fixed Shorty Buttstock | No Charge | Substitute M4 Style Handguard | \$15.00 |
| Substitute Aluminum CAR Stock | \$30.00 | Add Removable Carry Handle | \$85.00 |
| Substitute M4 Tactical Stock | \$30.00 | Add Magazine | \$35.00 |

9MM BARRELED UPPERS

All M&A 9MM Barreled Upper Assemblies come assembled and headspaced, complete with Bolt Carrier Group and Charging Handle Assembly.



9mm 16" CAR



Forged A2 or Forged Flattop Upper Receiver - Forged Front Sight Base

Match Grade Chrome-Moly 1:10 Twist Heavy Barrel - CAR Handguards with Heatshield

Pre-Ban 16" CAR	A2 Upper, Bayonet Lug, A2 Flash Suppressor	\$450.00
Pre-Ban 16" CAR	Flattop Upper, Bayonet Lug, A2 Flash Suppressor	\$450.00
Post-Ban 16" CAR	A2 Upper, 11° Target Crown	\$450.00
Post-Ban 16" CAR	Flattop Upper, 11° Target Crown	\$450.00
Post-Ban 16" CAR	A2 Upper, Permanent Muzzle Brake	\$490.00
Post-Ban 16" CAR	Flattop Upper, Permanent Muzzle Brake	\$490.00

9mm 16" CAR BARRELED UPPERS - OPTIONS AND UPGRADES

Substitute Green Furniture	\$15.00	Substitute Mid-Length Aluminum Free Float	\$40.00
Substitute M4 Style Handguard	\$15.00	Substitute Picatinny Gas Block	\$25.00
Substitute Mid-Length Handguard	No Charge	Add Removable Carry Handle	\$85.00
Substitute CAR Aluminum Free Float Tube	\$30.00	Add Magazine	\$35.00



9mm 11.5" Commando



Forged A2 or Forged Flattop Upper Receiver - Forged Front Sight Base

Match Grade Chrome-Moly 1:10 Twist Heavy Barrel - CAR Handguards with Heatshield

M16 only, 11.5" Commando	A2 Upper, Bayonet Lug, A2 Flash Suppressor	\$450.00
M16 only, 11.5" Commando	Flattop Upper, Bayonet Lug, A2 Suppressor	\$450.00

9mm COMMANDO BARRELED UPPERS - OPTIONS AND UPGRADES

Substitute Green Furniture	\$15.00	Add Removable Carry Handle	\$85.00
Substitute M4 Style Handguard	\$15.00	Add Magazine	\$35.00

9MM PARTS

9MM Forged A2 Upper Receiver Assembly . \$165.00

9MM Bolt Carrier Group	\$175.00
9MM Magwell Conversion Block	\$150.00
9MM Buffer	\$25.00
9MM Ejector	\$8.00
9MM Case Deflector with Spring	\$10.00
9MM Extractor	\$25.00
9MM Extractor Pin	\$1.00

9MM Forged Flattop Upper Receiver Assembly . \$150.00

9MM Carrier Key	\$20.00
9MM Firing Pin	\$12.00
9MM Firing Pin Spring	\$2.00
9MM Flash Hider	\$10.00
9MM Hammer	\$15.00
9MM Port Door Kit	\$10.00
9MM Stock Spacer	\$8.00

ORDERING INFORMATION

Hours of Operation:	9am to 5pm CST
CALL Your Order:	847-550-8246
FAX Your Order:	847-550-0654
Order ONLINE:	www.m-aparts.com

Customer Service... We Aim To Please!

If you have questions about merchandise or need help completing an order, please call us at 847-550-8246. M&A PARTS staff members will be happy to assist you in any way possible. If you are looking for something you don't see in our catalog or on our website, please give us a call and ask. There may be a configuration that we have on hand or that we can get that we don't currently have listed.

PAYMENT M&A PARTS is pleased to accept payment by VISA, Mastercard, Discover Card, cashier's check, money order or personal check. Orders paid for by personal check will be held for two weeks or until check clears. We also accept COD orders to the continental US. There is an additional \$7.00 UPS charge for COD shipments, and since UPS no longer accepts cash, payment must be in the form of a cashier's check or money order.

SHIPPING M&A PARTS ships via UPS Ground, Next Day Air, 2nd Day Air or 3rd Day Select. Estimated Shipping & Handling charges for UPS Ground shipment are listed on the order form on the next page. Some items may require higher shipping charges. Please call if you have any questions regarding your order.

RETURNS M&A PARTS wants you to be completely satisfied with your order. Please inspect your order upon receipt for any damage which may have occurred in shipping, and for any defects. If you are not satisfied with your purchase you may return it, unused and in the original packaging, within 30 days for your choice of an exchange, credit toward future purchase or refund of the purchase price, less original Shipping & Handling charges. Please call prior to returning any merchandise for a Return Authorization. M&A PARTS reserves the right to charge a 15% restocking fee on merchandise returned.

ADDRESS CORRECTION In order to assure the prompt delivery of orders and future catalog mailings, please inform an M&A PARTS staff member of any change in your shipping or mailing address. **Please be assured that M&A PARTS has never and will never share or sell your address to anyone!**

No FFL is required for the purchase of M&A Kits or Barreled Uppers. All NFA rules apply. Not responsible for typographical errors. All prices and specs subject to change without notice.

M&A PARTS INC.



527 Telser Road / Lake Zurich, IL 60047

Tel: 847-550-8246 / Fax: 847-550-0654

Orders Only: 888-MNA-1516 - Order Online at www.m-aparts.com

ALL PARTS MADE IN THE U.S.A. - AND PROUD OF IT!

MAIL/FAX ORDER FORM

Sold/Ship To:

Name _____

Address _____

City _____ State _____ Zip _____

Daytime Phone _____

Payment Method:

Money Order, Cashiers Check
or Certified Check enclosed



COD (Payable with Money Order or Cashiers Check only)

Card # _____

Name on Card _____ Exp. Date _____

Signature _____

ITEM DESCRIPTION	QTY	PRICE EA	TOTAL

How did you hear about M&A PARTS?

- Advertisement in Shotgun News
- Advertisement in Gun List
- At a Gun Show
- From a Friend
- Visited the M&A Website
- Received Catalog in the Mail
- Other: _____

Merchandise Sub Total:	_____
Illinois Residents add 6.5% Sales Tax:	_____
UPS COD Charge - \$7.00:	_____
Estimated Shipping - See Chart:	_____
Total:	_____

ESTIMATED SHIPPING AND HANDLING CHARGES:

Shipping & Handling charges are estimates based on UPS Ground shipment to the continental U.S., on pre-paid orders. Additional shipping charges may apply. Please call for Air charges and shipments to Alaska and Hawaii.

Order Total	S&H	Order Total	S&H
\$20 to \$50	----- \$6.95	\$200 to \$300	-- \$15.00
\$50 to \$100	---- \$7.95	\$300 to \$500	-- \$17.50
\$100 to \$150	--- \$9.75	\$500 to \$700	-- \$18.95
\$150 to \$200	-- \$11.00	\$700 or more	---- CALL

ASSAULT WEAPON INFORMATION

On September 14, 1994 the Bureau of Alcohol, Tobacco & Firearms ruled that the Crime Bill of 1994 prohibits the assembling of any AR-15 lower receiver into an Assault Rifle configuration. A semi-automatic Assault Rifle is defined as a rifle that has the ability to accept a detachable magazine and has any two or more of the following:

- A. Folding or telescopic stock
- B. Pistol grip that protrudes conspicuously beneath the action
- C. Bayonet mount
- D. Flash suppressor or threaded barrel designed to accommodate a flash suppressor
- E. Grenade launcher

You can build an AR-15 rifle by removing the bayonet lug mount and the barrel threads and not installing a telescoping stock. M&A PARTS can provide barrels in the legal configuration. If you have any questions about this law, please contact your nearest BATF office.

NOTE: M&A PARTS does not sell any parts or accessories for use in converting or altering any semi-auto weapon to fire fully automatic. Under Federal law, it is a felony for any individual to convert a semi-auto weapon to fire fully automatic. M&A PARTS is not responsible for the improper or illegal use of any parts sold to it's customers. If you need any help with any parts or accessories for your special needs, please ask. But never ask us to do anything illegal.

FAL STG58 PARTS SET

With all parts less receiver including hammer forged barrel, wire cutting flashider, and metal handguards.

In excellent condition with minor finish wear. For repair or replacement purposes only. All NFA rules apply.

FAL STG58 Parts Set . \$325.00



DSA FAL/SA58 Scope Mount	\$70.00	FAL Stock Tool	\$15.00
FAL Metric 20 Round Mags	\$10.00	FN FAL Manual	\$10.00

UZI PARTS SET

With all parts less receiver including synthetic pistol grip, folding stock, handguards and 25 round magazine. Excellent condition, FN South African contract. CA & NJ - mag not included. ALL NFA rules apply . . .

\$215.00

UZI Parts Set with all of above plus bayonet, sling, blank firing device and cleaning kit . **\$275.00**



UZI 25 Round Magazines	\$20.00	UZI Manual	\$5.00
----------------------------------	----------------	----------------------	---------------

BARREL ASSEMBLY PARTS

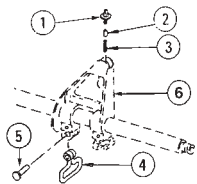

Front Sight Parts

- 1 Front sight post A2, square FS01 **\$3.00**
- 1A Front sight post A1, round FS02 **\$2.00**
- 2 Front sight detent FS03 **\$.50**
- 3 Front sight spring FS04 **\$.50**
- 4 Front swivel BL14 **\$3.00**
- 5 Front swivel rivet BL15 **\$1.00**
- 6 Front sight base, E2 heavy BL18 **\$35.00**
- Front sight pin, 2 required FS06 **\$1.00**

Barrel Assembly Parts

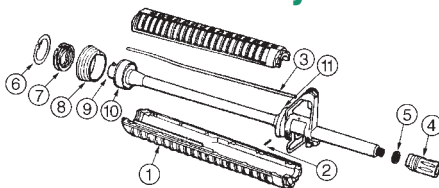

- 1 Handguards - See Page 25
- 2 Gas tube roll pin BL03 **\$.50**
- 3 Gas tube, standard BL03 **\$10.00**
- 3A Gas tube, CAR BL04A **\$10.00**
- 3B Gas tube, mid-length carbine BL04B **\$10.00**
- 4 Compensator, A2 BL06A2 **\$5.00**
- 4A Compensator, A1 BL05A1 **\$5.00**
- 5 Crush washer, flash suppressor BL06PW **\$2.00**
- 5A Compensator lock washer, A1 BL06LW **\$1.00**
- 6 Barrel snap ring BL07 **\$1.00**
- 7 Weld spring BL08 **\$4.00**
- 8 Delta ring, aluminum mil-spec BL09 **\$7.00**
- 9 Barrel extension BL17 **\$15.00**
- 10 Barrel nut BL16 **\$5.00**
- Barrel Nut Assembly **\$12.00**
- 11 Handguard cap, round BL19 **\$2.00**
- 11A Handguard cap, triangular BL19A **\$2.00**



Steel Gas Block with Rail
\$45.00
.750" Barrel Diameter



Aluminum Gas Block with Rail

.750" Barrel Diameter **\$25.00**
.950" Barrel Diameter **\$25.00**

Gas Tubes

- Standard Handguard **\$10.00**
- Mid-length Handguard **\$10.00**
- CAR Handguard **\$10.00**



A1 Flash Hider
\$5.00

A2 Flash Hider
\$5.00

3 Prong Flash Hider
\$15.00



Phantom Flash Hider
\$25.00



5 1/2 Inch Flash Hider
\$15.00



Reverse Flash Hider
\$15.00



Muzzle Brake Post-Ban
\$20.00



Muzzle Brake
\$20.00



Muzzle Brake
\$20.00



Detachable Front Sight
\$35.00



Flip-up Detachable Front Sight
\$75.00

Y/M Gas Block with Flip-up Front Sight
\$100.00



BARREL ASSEMBLIES

5.56 NATO Barrel Assemblies Match Grade Chrome-Moly

16"/20"/24" 1:9 Twist Heavy



16" Pre-Ban **\$130.00**
 16" Pre-Ban, Fluted **\$180.00**



16" Post-Ban, Mock Suppressor . **\$130.00**
 16" Post-Ban, Muzzle Brake **\$180.00**
 16" Post-Ban, Fluted **\$180.00**



16" Post-Ban, 11° Target Crown . **\$130.00**



16" Post-Ban, Fluted, Mock Suppressor. **\$180.00**



20" Pre-Ban **\$130.00**
 24" Pre-Ban **\$130.00**



20" Pre-Ban, Fluted **\$180.00**
 24" Pre-Ban, Fluted **\$180.00**



20" Post-Ban, Mock Suppressor . **\$130.00**
 20" Post-Ban, Muzzle Brake **\$180.00**
 20" Post-Ban, 11° Target Crown. **\$130.00**
 20" Post-Ban, Fluted **\$180.00**
 24" Post-Ban, Mock Suppressor . **\$130.00**
 24" Post-Ban, Fluted **\$180.00**

20" 1:7 Twist A2



20" Pre-Ban, Chrome Lined. . . . **\$140.00**

5.56 NATO Barrel Assemblies Match Grade Chrome-Moly

14.5"/16" M4 1:9 Twist



14.5" M16 only. **\$180.00**
 16" Pre-Ban **\$180.00**



16" Post-Ban, Mock Suppressor . **\$180.00**
 16" Post-Ban, Muzzle Brake **\$230.00**

16" 1:9 Twist Mid-Length



16" Pre-Ban **\$155.00**
 16" Post-Ban, 11° Target Crown. **\$155.00**

16" XM 1:9 Twist Heavy



16" Pre-Ban, 11.5" Barrel with Permanently Attached 5.5" Flash Hider **\$165.00**

16" 1:9 Twist Lightweight



16" Pre-Ban **\$155.00**
 16" Post-Ban, 11° Target Crown. **\$155.00**

10.25"/11.5" 1:9 Twist Heavy

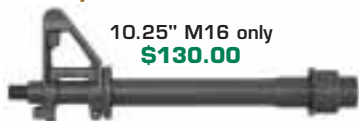

10.25" M16 only
\$130.00



11.5" M16 only
\$130.00

BARREL ASSEMBLIES

5.56 NATO Barrel Assemblies Match Grade Stainless Steel

16" 1:8 Twist Heavy



16" Pre-Ban **\$180.00**
16" Pre-Ban, Fluted **\$230.00**



16" Post-Ban, 11° Target Crown . **\$180.00**
16" Post-Ban, Muzzle Brake **\$230.00**
16" Post-Ban, Fluted **\$230.00**

20" 1:8 Twist Heavy



20" Pre-Ban **\$180.00**
20" Pre-Ban, Fluted **\$230.00**



20" Post-Ban, 11° Target Crown . **\$180.00**
20" Post-Ban, Muzzle Brake **\$230.00**
20" Post-Ban, Fluted **\$230.00**

16"/20"/24" 1:8 Twist Varmint



16" Varmint **\$200.00**
16" Varmint, Fluted **\$250.00**



20" Varmint **\$200.00**
20" Varmint, Fluted **\$250.00**

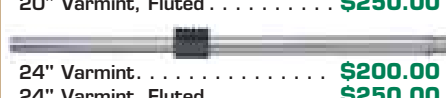

24" Varmint **\$200.00**
24" Varmint, Fluted **\$250.00**



**Bayonet Lug
Adapter \$20.00**

Heavy or Light

**Muzzle Cap
\$1.00**



7.62x39 Barrel Assemblies Match Grade Chrome-Moly

20"/16"/11.5" 1:9 Twist Heavy



20" Pre-Ban **\$165.00**



20" Post-Ban, Mock Suppressor . **\$165.00**



16" Pre-Ban **\$165.00**



16" Post-Ban, Mock Suppressor . **\$165.00**



11.5" M16 only **\$165.00**

9mm Barrel Assemblies Match Grade Chrome-Moly

16"/11.5" 1:10 Twist Heavy



CAR Length

16" Pre-Ban **\$165.00**
16" Post-Ban, 11° Target Crown . **\$165.00**
16" Post-Ban, Muzzle Brake **\$215.00**



Mid-Length

16" Pre-Ban **\$165.00**
16" Post-Ban, 11° Target Crown . **\$165.00**
16" Post-Ban, Muzzle Brake **\$215.00**



11.5" M16 only **\$165.00**

UPPER RECEIVERS & RELATED



G.I. Forged A2 Upper

Stripped \$90.00
 Complete \$125.00



G.I. Forged Flattop Upper

Stripped \$90.00
 Complete \$110.00



Forged Flattop Hi-Rise Upper

\$110.00



G.I. Forged A1 Upper

Stripped \$90.00
 Complete \$115.00

G.I. Forged Carry Handle

\$100.00



Rock River Arms Tactical Carry Handle

\$175.00



Forged Tactical Upper

Complete \$175.00

Charging Handles



Standard
\$15.00

Extended
\$20.00

Tactical
\$28.00

Charging handle roll pin UR16 \$.50
 Charging handle latch spring UR17 \$.50
 Charging handle latch UR18 \$ 3.00
 Stripped handle UR19B \$12.00
 Extended latch only \$8.00

Detachable Rear Sight \$75.00



Flip-up A2 ERS \$85.00



Multi Aperture Detachable Rear Sight \$75.00



Non-Flip Detachable Rear Sight \$50.00



Tactical Ambi Charging Handle Latch
\$15.00

UPPER RECEIVERS PARTS

Upper Receiver Parts

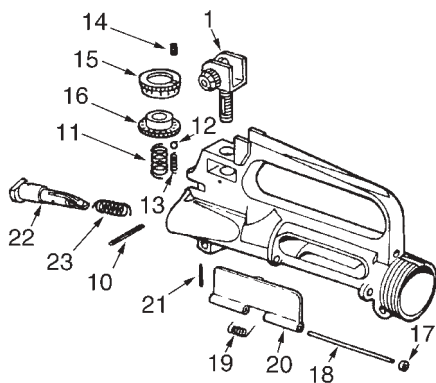
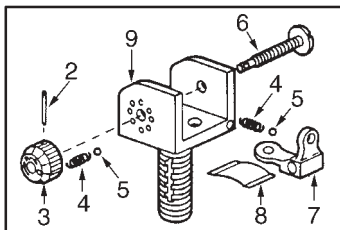

- 1 Rear Sight Complete, A2 UR21 **\$35.00**
- 1A Rear Sight Complete, National Match **\$45.00**
- 2 Rear sight spring pin UR22 **\$ 5.00**
- 3 Rear sight windage knob UR23 **\$ 7.00**
- 3A Rapidex windage knob UR24 **\$ 8.00**
- 4 Rear sight knob spring, 3 required UR24 **\$ 5.00**
- 5 Rear sight knob ball bearing, 3 required UR25 **\$ 5.00**
- 6 Rear sight windage knob screw UR26 **\$ 2.00**
- 7 Rear sight aperture, A2 UR27 **\$ 8.00**
- 8 Rear sight flat spring, A2 UR28 **\$ 1.00**
- 9 Rear sight base, A2 UR29 **\$17.50**
- 10 Rear sight spring pin, 2 required UR30 **\$ 5.00**
- 11 Rear sight elevation knob spring UR31 **\$ 5.00**
- 12 Rear sight base ball bearing, 3 required UR25 **\$ 5.00**
- 13 Rear sight base spring, 3 required UR24 **\$ 5.00**
- 14 Rear sight index screw, A2 UR32 **\$ 1.00**
- 15 Rear sight index elevation UR33 **\$ 7.00**
- 16 Rear sight elevation knob UR34 **\$ 7.00**
- 17 Ejection hinge pin snap ring UR02 **\$ 5.00**
- 18 Ejection port cover pin UR03 **\$ 1.00**
- 19 Ejection port cover spring UR05 **\$ 5.00**
- 20 Ejection port cover UR04 **\$ 8.00**
- 20A Ejection Port Cover Assembly UR05A **\$ 9.00**
- 21 Forward assist pin UR06 **\$ 5.00**
- 22 Forward Assist Assembly, round... UR08R **\$10.00**
- 22A Forward Assist Assembly, teardrop . UR08T **\$15.00**
- 23 Forward assist spring UR07 **\$ 5.00**

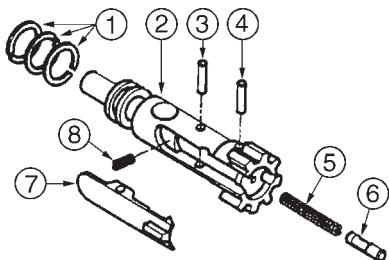

Bolt Assembly Parts

- 1 Bolt gas ring, set of 3 BT01 **\$2.00**
- 2 Bolt BT02 **\$28.00**
- 2A Bolt, with ejector installed BT02A **\$33.00**
- 3 Extractor pin BT03 **\$1.00**
- 4 Ejector roll pin BT04 **\$ 5.00**
- 5 Extractor spring BT05 **\$ 5.00**
- 6 Ejector BT06 **\$ 4.00**
- 7 Extractor BT07 **\$10.00**
- 8 Extractor spring BT08 **\$ 1.00**
- Extractor Assembly **\$11.00**
- Complete Bolt Assembly, assembled BT09 **\$45.00**

7.62x39mm Bolt Assembly

Complete **\$60.00**

7.62x39mm Extractor Assembly . **\$18.00**

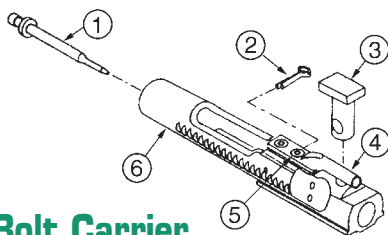

Bolt Carrier Assembly Parts

- 1 Firing pin, AR15 BT14 **\$ 7.00**
- 2 Firing pin retaining pin BT16 **\$ 1.00**
- 3 Cam pin BT17 **\$ 4.00**
- 4 Bolt carrier key BT11 **\$ 7.00**
- 5 Bolt carrier key screw, 2 required BT10 **\$ 5.00**
- 6 Bolt carrier, AR15 BT13 **\$55.00**
- Bolt carrier with key, AR15 BT19 **\$63.00**

Bolt Carrier Assembly

Complete **\$110.00**

Chrome Bolt Carrier Assembly

Complete **\$185.00**

7.62x39 Bolt Carrier Assembly

Complete **\$130.00**

UPPER RECEIVER PARTS

M16/Full Auto Parts

All N.F.A. Rules Apply

FFL Class II, Class III and Tax Stamp Licensee only

Firing pin, M16	BT15	\$7.00
Bolt carrier, M16	BT12	\$55.00
Bolt carrier with key, M16	BT20	\$63.00
Complete Bolt Carrier Assembly, M16	BCBA16	\$110.00
Disconnecter, M16	LR19A	\$5.00
Hammer, M16	LR34	\$15.00
Trigger, M16	LR21	\$12.00
Safety selector, M16	LR08A	\$10.00

Auto Sear

With Pin **\$15.00**



Burst Kit	BUTRI	\$75.00
Burst cam	BU01	\$8.00
Burst disconnecter	BU02	\$15.00
Burst disconnecter	BU03	\$12.00
Burst hammer	BU04	\$25.00
Burst hammer spring	BU05	\$3.00
Burst trigger	BU06	\$22.00
Burst trigger spring	BU07	\$3.00
Burst disconnecter spring, 2 required	BU08	\$5.00
Burst cam spring	BU09	\$6.00

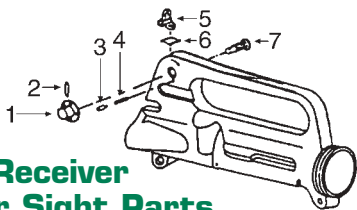

A1 Receiver Rear Sight Parts

Rear Sight Complete, A1		\$11.00
1 Rear sight windage drum, A1	UR09E3	\$2.00
2 Rear sight base spring pin, A1	UR10E3	\$5.00
3 Rear sight detent, A1	UR11E3	\$5.00
4 Rear sight detent spring, A1	UR12E3	\$5.00
5 Rear sight flat spring, A1	UR28	\$1.00
6 Rear sight aperture, A1	UR13E3	\$6.00
7 Rear sight windage screw, A1	UR14E3	\$2.00

D The D-Fender Extractor D-Ring . . . \$12.00



Accu-Wedge Buffer

Eliminates play between upper and lower receiver, drop-in installation **\$5.00**

LOWER RECEIVER PARTS

Complete Lower Receiver Parts Sets



Lower Parts Set With Pistol Grip

AR15	\$55.00
M16, without M16 sear	\$55.00
M16, with M16 sear & pin	\$70.00

Rock River Arms

National

Match

Two Stage

Trigger **\$120.00**



Field Repair Kit. **\$30.00**

Lower Receiver

Spring Kit

\$5.00



Lower Receiver

Pin & Detent Kit

\$10.00

LOWER HALF PARTS & RELATED

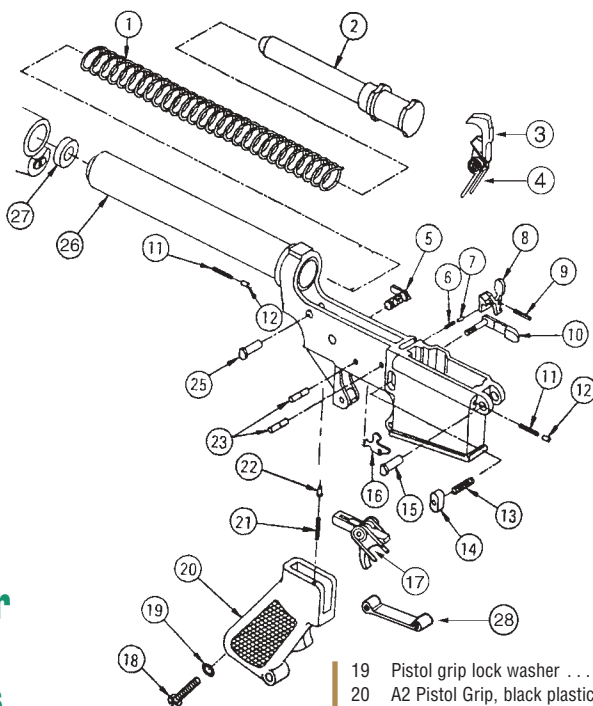

Lower Half Parts

1	Buffer spring, standard	BS	\$2.00
1A	Buffer spring, CAR	BS10A	\$2.00
2	Buffer, standard	BS11	\$10.00
2	Buffer, CAR	BS11A	\$10.00
3	Hammer, AR15/M16	LR32	\$15.00
3A	Hammer, Colt large diameter		\$22.50
4	Hammer spring		\$1.00
5	Safety Selector, AR15/M16	LR08	\$10.00
5A	Ambi Safety Selector, AR15		\$27.00
6	Bolt catch spring	LR09	\$0.50
7	Bolt catch buffer/plunger	LR10	\$0.50
8	Bolt catch	LR11	\$4.50
9	Bolt catch roll pin	LR12	\$0.50
10	Magazine catch	LR13	\$3.50
10A	Magazine Catch Assembly	LR13A	\$6.00
11	Takedown pin detent spring	LR14	\$0.50
12	Takedown pin detent	LR15	\$0.50
13	Magazine catch spring	LR16	\$0.50
14	Magazine catch button, aluminum	LR17	\$2.00
15	Front pivot pin	LR18	\$3.00
16	Disconnecter, AR15/M16	LR19	\$5.00
16A	Disconnecter, Colt large diameter		\$10.00
16B	Disconnecter spring		\$0.50
17	Trigger, AR15/M16	LR20	\$12.00
17A	Trigger, Colt large diameter		\$17.50
17B	Trigger spring	LR22	\$1.00
18	Pistol grip screw	LR23	\$1.00

19	Pistol grip lock washer	LR24	\$0.50
20	A2 Pistol Grip, black plastic	LR25	\$5.00
21	Selector spring	LR26	\$0.50
22	Selector detent	LR27	\$0.50
23	Trigger pin	LR28	\$0.50
23A	Trigger pin, Colt large diameter		\$10.00
23B	Hammer pin	LR29	\$0.50
23C	Hammer pin, Colt large diameter		\$2.00
25	Takedown pin, rear	LR30	\$3.00
26	Buffer tube, standard		\$1.00
26A	Buffer tube, CAR		\$15.00
	Buffer tube detent		\$0.50
	Buffer tube detent spring		\$0.50
27	Buttstock spacer	BS12	\$3.00
28	Trigger guard, aluminum		\$5.00
28A	Trigger guard pin		\$0.50
A2	Buttstock, with butt plate	BS13	\$35.00
	Butt Plate Assembly	BS18	\$15.00
	Buttstock screw, upper, A2	BS14	\$1.00
	Buttstock screw, upper, A1/old	BS14A	\$1.00
	Buttstock door assembly	BS01	\$12.00
	Buttstock plate	BS02	\$3.00
	Buttstock hinge	BS03	\$2.00
	A2 Buttstock, stripped	BS04	\$20.00
	Buttstock swivel	BS05	\$3.00
	Buttstock swivel rivet	BS06	\$1.00
	Buttstock screw, lower, A2	BS07	\$1.00
	Buttstock screw, lower, A1/old	BS08	\$1.00
	Offset Pivot Pin, GI upper to large pin lower		\$5.00
	Offset Pivot Bushing, GI lower to large pin upper		\$5.00

AR FURNITURE & RELATED



Complete A2 Buttstock Assembly

Includes buttstock with buttplate, buffer, buffer tube, buffer spring and stock spacer.

- Black **\$55.00**
- Green **\$60.00**



CAR Stock

Complete with buffer and spring.

Pre-Ban 4 Position Collapsible

- Black **\$55.00**
- Green **\$60.00**

Post-Ban Fixed Position

- Black **\$55.00**
- Green **\$60.00**



Tactical Fixed Shorty Stock

Complete with buffer and spring.

- Black **\$55.00**
- Green **\$60.00**



M4 Tactical Stock

Space age plastic, built-in swivel, complete with buffer and spring.

Pre-Ban 6 Position Collapsible

- Black **\$85.00**
- Green **\$90.00**

Post-Ban Fixed Position

- Black **\$85.00**
- Green **\$90.00**



ACE Skeleton Stock

Fixed position, super rigid 6061 aluminum tubing, thick closed cell foam cheek pad, includes buttpad and QD sling swivel and swivel mount.

- Standard 10.5" **\$85.00**
- CAR 7.75", includes tube . . . **\$95.00**



Aluminum CAR Stock

Complete with buffer and spring.

Pre-Ban 4 Position Collapsible

- Black **\$85.00**



ACE M4 SOCOM Stock

5 position pre-ban stock, adjustable 7.5" to 9.5", with 4 sling mounts, recoil pad.

- M4 SOCOM Stock **\$185.00**

CAR Butt pads



- 1) M4 Extended CAR Buttpad . . . **\$20.00**
- 2) CAR Buttpad **\$10.00**
- 3) .75" Extended CAR Buttpad. . . **\$15.00**
- 4) 1.5" Extended CAR Buttpad. . . **\$15.00**

AR FURNITURE & RELATED

Tiger Stripe Camouflage Furniture Sets



Tiger Stripe

A2 Handguard, Buttstock and Pistol Grip
Standard Furniture Set. \$145.00



Tiger Stripe

CAR Handguard,
 CAR Stock and Pistol Grip
CAR Furniture Set. \$145.00

Cherokee Accessories

Delta Cheekpiece

Improved cheekweld,
 high impact plastic,
 easy and secure install.

Black **\$55.00**
 Green **\$60.00**



Cherokee Accessories

CAR Cheekpiece

For Colt Style CAR Stocks
 Black. **\$25.00**

For M4 Style CAR Stocks
 Black. **\$25.00**



A2 Pistol Grips

Black **\$5.00**
 Green **\$7.00**

Hogue Grips

Black . . . **\$20.00**
 Green . . . **\$25.00**



**First SAMCO
 Tactical Grip
 \$25.00**



**ERGO Grip
 AR Grip
 \$25.00**



**Target Grip
 Palm Rest
 \$35.00**



**Trapdoor
 Grip
 \$10.00**



Clip-A-Grip
 A2 grip attachment
\$25.00

**Pistol
 Grip Plug \$5.00**



A2 Buttstock Weight Wedge \$20.00
 Solid lead wedge fits snugly in A2 stock, provides weight and balance for increased accuracy.

AR FURNITURE & RELATED



Standard E2 Handguard

Black \$18.00
Green \$23.00



CAR Handguard

Black \$15.00
Green \$20.00

NM Free Float Barrel Sleeve



With gas tube \$100.00

Aluminum Free Float Tubes



Standard, Knurled \$40.00
Standard, Knurled, Vented . . \$40.00



M4 Style Handguard

Black \$25.00
Green \$30.00



CAR, Knurled \$40.00
CAR, Knurled, Vented \$40.00



Mid-Length Carbine Handguard

Black \$18.00
Green \$23.00

Four Rail Handguards



Standard Free Float . . . \$145.00



CAR Free Float. \$145.00



Flattop Free Float \$175.00



First SAMCO Rail System Handguard Sets

With 4 rails and protective rail covers
Rifle Length Rail Handguard
M44L \$105.00
Carbine Length Rail Handguard
M44S \$105.00

AR FURNITURE & RELATED



First SAMCO
Universal Equipment
Mount \$25.00



S.O.G. Graphite
Vertical Fore Grip
\$40.00

First SAMCO
Vertical Fore Grip
\$45.00



Y/M Aluminum
Vertical Fore Grip
\$50.00



Universal Rail

For standard handguard **\$25.00**



Universal Mounting Platforms

4 Inch Platform **\$20.00**
 2 Inch Platform **\$15.00**

Clip-On Rail Covers

Covers
 15 slots . . . **\$12.00**
 Covers
 10 slots . . . **\$8.00**
 Covers 5 slots . . . **\$5.00**
 Slotted Clip-on Rail Cover **\$5.00**



G.I. Sling
 Used **\$3.00**

CMP Nylon A2 Sling \$10.00



Versa-Pod Bipod
 9" - 12" adjustable leg height **\$65.00**

Versa-Pod Mounting Adapters

Pre-ban Snaps on to bayonet lug . . . **\$20.00**



For M-14/M-1A, Replaces gas plug **\$20.00**



Universal Bipod

Mounts to rail under handguard, universal mount platform. Closed 7 - 10.5" height adjustment **\$25.00**



S.O.G. Side Sling Adapter and Rail \$35.00



Front Sight Sling Adapter \$20.00

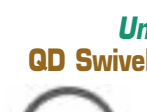

G.I. Side Sling Adapter \$35.00

Uncle Mike's QD Swivel and Stud \$10.00



CAR Tactical Plate \$12.00

CAR Ambi Tactical Plate \$10.00



MAGS & ACCESSORIES



AR Magazines

- Aluminum
5 Round **\$15.00**
- Aluminum
9 Round **\$15.00**
- Commercial
30 Round **\$20.00**
- GI 30 Round **\$35.00**

Green AR Mag Followers

- 20 Round . . . **\$2.00**
- 30 Round . . . **\$2.00**
- Three for . . . **\$5.00**



AR 30 Round  **Mag Spring \$2.00** - Three for **\$5.00**

MORE MAGAZINE VALUES

- AK47 7.62x39, 20 round **\$35.00**
- AK47 7.62x39, 30 round **\$15.00**
- AK47 7.62x39, 40 round **\$35.00**
- AK47 7.62x39, 75 round Drum . **\$125.00**
- BAR **\$15.00**
- FAL .308, Metric 20 round **\$10.00**
- Grease Gun .45, 30 round **\$10.00**
- HK91/G3 .308, 30 round **\$10.00**
- HK MP5 9mm, 30 round **\$35.00**
- Mini 14, 10 round **\$15.00**
- SKS 7.62x39, 5 round **\$15.00**
- SKS 7.62x39, 10 round **\$15.00**
- SKS 7.62x39, 30 round **\$25.00**
- Sten 9mm, 20 round **\$10.00**
- UZI 9mm, 25 round **\$20.00**
- .45 ACP G.I. **\$11.00**



BAGMASTER

Tactical Weapon Cases

Black 600 denier polyester outer shell, inner liner of soft, brushed tricot nylon bonded to 3/4" high density foam, wrap-around handles and adjustable shoulder strap, zippered accessory pocket and four external map pockets.

- 35" Tactical Weapon Case **\$60.00**
- 38" Tactical Weapon Case **\$65.00**
- 42" Tactical Weapon Case **\$65.00**
- 46" Tactical Weapon Case **\$70.00**



Boonie Packer REDI-MAG RM-15 A2

Speed Loading System for AR .223 caliber magazines . **\$75.00**



First SAMCO .223 Mag Coupler **\$10.00**



Buffer Technologies .223 MagCinch **\$19.00**



LULA AR Mag Loader

Loads and unloads .223 mags
\$25.00



Mag Loader For AR-15, M-16, Mini-14 **\$15.00**

MagPul

For .223 Mags
Each **\$4.00**
Three for **\$10.00**



.223 Caliber Stripper Clips

Package of 50 **\$6.00**



.223 Chargers Three count **\$2.00**

Universal Brass Catcher **\$20.00**



Pistol Tactical Lanyard **\$18.00**

MANUALS / BAYONETS



U.S. Marine Corps
Rifle, 5.56mm, M16A2
W/E Technical Manual
\$5.00



Dept. of the Army
U.S. Rifles, 7.62mm
M14 & M14E2 Manual
\$5.00



War Department
U.S. Rifles, Cal. .30 M1,
M1C & M1D Manual
\$5.00



Dept. of the Army
Cal. .30 Carbines, M1,
M1A1, M2 & M3
\$5.00



Dept. of the Army
Pistol, Caliber .45,
Automatic, M1911A1
\$5.00



Dept. of the Army
SNIPER Training and
Employment
\$5.00



Imbel
Light Automatic Rifle
7.62mm FAL Manual
\$10.00



Fabrique Nationale
UZI SMG Cal. 9mm Para
Operation Manual
\$5.00



AR15 Bayonet
Bayonet **\$25.00**
Bayonet with scabbard **\$30.00**
M10 Scabbard only **\$10.00**



M14 Bayonet
Bayonet **\$45.00**
Bayonet with scabbard **\$55.00**
M8 Scabbard only **\$12.00**



M1/M2 Carbine Bayonet
Bayonet **\$30.00**
Bayonet with scabbard **\$40.00**
M8 Scabbard only **\$12.00**



M1 Garand Bayonet
Bayonet **\$40.00**
Bayonet with scabbard **\$50.00**
M8 Scabbard only **\$12.00**

TOOLS AND MORE

Buttstock Cleaning Kit



\$15.00



Bore Stay Bore Guide . . . \$25.00

Cotton Cleaning Patches

Box of 1,000. **\$5.00**

AR15 Bolt Tool \$35.00



Broken Shell Extractor \$10.00



Upper Receiver Vise Clamp \$30.00

Lower Vise Clamp \$20.00



Aluminum Barrel Vise Jaws \$15.00

Shooting Gloves \$6.00



Armorer's Wrench \$30.00



Barrel Wrench \$10.00



CAR Spanner Wrench \$3.00



CAR Stock Wrench \$6.00
For new G.I. type lock ring



A1 Front Sight Tool . . . \$7.00



A2 Front Sight Tool \$7.00



AR Handguard Removal Tool \$15.00



Pivot Pin Installation Tool . . . \$6.00



Pivot Pin Removal Tool \$4.00



SUREFIRE G2 Nitrolon Flashlight

Featuring a push button switch, black Nitrolon body and Super Xenon lamp. Comes with two DL123A Lithium batteries.

SureFire G2-BK \$40.00

SCOPES & MOUNTS



EOTech

Holographic Diffraction Sight

Locks onto the target as fast as your eyes do!

In use by Military and Law Enforcement throughout the world. 1X Holographic sight, 100% parallax-free, with 20 brightness settings and unlimited eye relief.

EOTech 511 "N" Battery Model. . . **\$300.00**

EOTech 512 "AA" Battery Model. **\$355.00**

Night Vision Compatible Models:

EOTech 551 "N" Battery Model. . . **\$355.00**

EOTech 552 "AA" Battery Model. **\$395.00**



Elcan Optical Sight **\$725.00**

Complete with mount assembly for quick attachment to standard mil-std picatinny rail. 3.4X nominal magnification with extra large exit pupil for fast target acquisition. External ballistic compensation dial, calibrated for .223 caliber. The most popular combat optical sight for Law Enforcement and military applications.

Also available for 7.62 NATO . . . **\$725.00**

Target Sports 4x30RE AR Scope

With Lighted Reticle . . . **\$55.00**



Rubber armored scope with quick-detach see-thru mount, no gunsmithing required.



Heavy Duty 30mm Rings
with 1" spacers
\$85.00



Flattop Scope Mount
\$45.00



Flattop Riser Mount **\$35.00**



Mini Riser
Set of two
\$25.00



USTS Carry Handle Mount **\$25.00**



See-Thru Handle Mount
\$8.00



A2 Co-witness Mount **\$45.00**

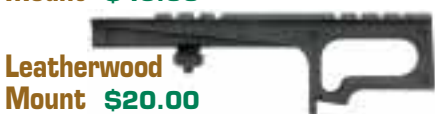

Leatherwood Mount **\$20.00**



\$70.00
DSA FAL Mount

M14 PARTS / M1-M2 CARBINE PARTS

7.62 NATO M14 PARTS

M14 Bipod \$50.00

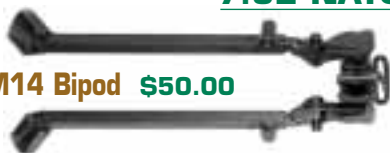

M14/M1A Mount \$50.00



Barrel	\$150.00
M14 Bayonet	\$45.00
M14 Bayonet with scabbard	\$55.00
M8 Scabbard only	\$12.00
Blank Firing Adaptor	\$10.00
Bolt Assembly Tool	\$50.00
Bolt, Stripped, NEW.	\$75.00
Bolt Roller	\$2.00
Bolt Stop	\$13.00
Bolt Stop Pin	\$1.00
Bolt Stop Spring	\$1.00
Butt Swivel	\$3.00
Buttplate Assembly	\$15.00
Buttplate Screw, Upper	\$1.00
Buttplate Screw, Lower	\$1.00
Cleaning Kit	\$15.00
Clip Guide	\$10.00
Clip Guide Pin	\$1.00
Combo Tool	\$4.00
Connector Rod	\$12.00
Connector Lock	\$3.00
Connector Lock Pin	\$1.00
Ejector with Spring	\$7.00
Extractor	\$12.00
Extractor Spring & Plunger	\$3.00
Firing Pin	\$15.00
Flash Suppressor	\$45.00
Flash Suppressor Nut	\$2.00
Flash Suppressor Nut Set Screw	\$1.00
Front Band	\$15.00
Front Sight	\$10.00
Front Sight, National Match	\$15.00
Front Sight Screw	\$1.00
Gas Cylinder	\$65.00
Gas Cylinder Lock	\$10.00
Gas Cylinder Plug	\$10.00
Gas Piston	\$20.00
Hammer	\$15.00
Hammer Pin	\$2.00
Hammer Spring	\$2.00
Hammer Spring Housing	\$7.00
Hammer Spring Plunger	\$2.00
Magazine, 20 Round GI	\$50.00
Magazine, 5 or 10 Round	\$25.00
Magazine Catch	\$10.00
Magazine Catch Spring	\$1.00
Magazine Catch Pin	\$1.00
Muzzle Stabilizer	\$40.00
Operating Rod	\$100.00
Operating Rod Guide	\$15.00
Operating Rod Guide Pin	\$1.00

Operating Rod Spring	\$4.00
Operating Rod Spring Guide	\$10.00
Operating Rod Spring Guide NM	\$15.00
Rear Sight Aperture	\$8.00
Rear Sight Base	\$10.00
Rear Sight Base, National Match	\$40.00
Rear Sight Cover	\$3.00
Rear Sight Elevation Knob	\$20.00
Rear Sight Windage Knob	\$10.00
Safety	\$10.00
Safety Spring	\$2.00
Sear Release	\$10.00
Selector	\$5.00
Selector Pin	\$1.00
Selector Shaft	\$10.00
Selector Spring	\$1.00
Selector Shaft Lock	\$3.00
Spindle Valve	\$5.00
Spindle Valve Spring	\$1.00
Spindle Valve Retaining Pin	\$1.00
Stock, Birch, Very Good Condition	\$40.00
Trigger & Sear Assembly	\$8.00
Trigger Guard	\$20.00
Trigger Housing	\$75.00
Trigger Housing Assmly Complete	\$125.00
Trigger Pin	\$2.00

M1-M2 CARBINE PARTS

M1/M2 Band Assembly w/Bayo Lug	\$15.00
M1/M2 Bayonet	\$30.00
M1/M2 Bayonet with scabbard	\$40.00
M8 Scabbard only	\$12.00
M1/M2 Bolt Tool	\$15.00
M2 Disconnecter Block	\$12.00
M2 Disconnecter Spring & Plunger	\$3.00
M2 Disconnecter Lever	\$15.00
M1/M2 Handguard, Ventilated Steel	\$10.00
M2 Magazine Catch	\$10.00
M1 Magazine, 30 Round GI	\$22.00
M1 Magazine, 15 Round GI	\$10.00
M1/M2 Scope Mount	\$15.00
M2 Sear	\$10.00
M2 Selector Spring	\$2.00
M2 Selector Switch	\$15.00
M2 Slide	\$40.00
M1/M2 Sling with Oiler	\$10.00
M1/M2 Stock Pouch,	
USGI 1943 Dated	\$25.00
M2 Trigger Housing, stripped	\$40.00

M1 GARAND PARTS / .45 AUTO PARTS



M1 GARAND PARTS

Grenade Launcher Sight \$10.00

M1 Garand Bayonet	\$40.00
M1 Garand Bayonet with scabbard	\$50.00
M8 Scabbard only	\$12.00
Blank Firing Adapter	\$10.00
Bolt Complete	\$75.00
Bolt Stripped	\$50.00
Bolt Tool	\$50.00
Bullet Guide	\$5.00
Buttplate, used, OK	\$10.00
Butt Screw, Lower	\$1.00
Butt Screw, Upper	\$1.00
Buttswivel	\$3.00
Clip Ejector	\$2.00
Clip Latch	\$8.00
Clip Latch Pin	\$1.00
Clip Latch Spring	\$1.00
Ejector with Spring	\$7.00
Extractor	\$12.00
Extractor Plunger	\$2.00
Extractor Spring	\$1.00
Firing Pin	\$10.00
Follower Arm	\$4.00
Follower Arm Pin	\$2.00
Follower Rod	\$5.00
Front Sight	\$10.00
Front Sight, National Match	\$15.00
Front Sight Screw	\$1.00
Gas Cylinder	\$55.00



Grenade Launcher Adapter \$20.00

Gas Cylinder Lock	\$10.00
Gas Cylinder Lock Screw	\$7.00
Hammer	\$15.00
Hammer Pin	\$2.00
Hammer Spring	\$2.00
Hammer Spring Housing	\$7.00
Hammer Spring Plunger	\$2.00
Lower Band	\$10.00
Lower Band Pin	\$1.00
Operating Rod Catch Assembly	\$12.00
Operating Rod	\$65.00
Operating Rod Spring	\$5.00
Prong Flash Suppressor, T-37	\$45.00
Rear Handguard Clip	\$5.00
Rear Sight Aperture	\$8.00
Rear Sight Base	\$10.00
Rear Sight Base, National Match	\$40.00
Rear Sight Cover	\$3.00
Rear Sight Elevation Knob	\$20.00
Rear Sight Windage Knob	\$10.00
Safety	\$10.00
Slide & Follower Assembly	\$12.00
Sling, Canvas	\$5.00
Stock Front Ferrule Assembly	\$10.00
Trigger & Sear	\$8.00
Trigger Housing	\$25.00
Trigger Pin	\$2.00
Trigger Guard, Stamped	\$10.00
Trigger Housing, complete	\$75.00

1911 & A1 .45 AUTO PARTS

Barrel Bushing	\$7.00
Barrel Bushing, National Match	\$10.00
Barrel Link	\$3.00
Barrel Link Pin	\$1.00
Bushing Wrench	\$1.00
Commander Hammer	\$12.00
Disconnecter	\$10.00
Ejector	\$4.00
Ejector Pin	\$1.00
Extractor	\$10.00
Firing Pin	\$4.00
Firing Pin Spring	\$1.00
Firing Pin Stop	\$3.00
Grip Screw	\$1.00
Grip Screw Bushing	\$1.00
Grip Safety	\$10.00
Grip Wood, Diamond	\$15.00
Hammer, Standard	\$7.00
Hammer, Wide Spur	\$12.00
Hammer Strut Pin	\$1.00
Hammer Strut	\$4.00
Magazine, Blue GI	\$12.00
Magazine, Stainless Aftermarket	\$10.00
Magazine Catch	\$8.00
Magazine Catch Lock	\$2.00

Magazine Catch Spring	\$1.00
Mainspring	\$1.00
Mainspring Housing, Flat Serrated	\$15.00
Mainspring Housing, Arched	\$15.00
Mainspring Housing Detent	\$1.00
Mainspring Housing Pin	\$1.00
Plunger Tube	\$5.00
Plunger Tube Slide Stop Detent	\$1.00
Plunger Tube Thumb Safety Detent	\$1.00
Plunger Tube Spring	\$1.00
Rear Sight Standard	\$5.00
Recoil Spring	\$2.00
Recoil Spring Guide	\$4.00
Recoil Spring Plug	\$4.00
Sear	\$10.00
Sear Spring	\$4.00
Sear Pin	\$1.00
Slide Stop	\$10.00
Slide Stop, Extended	\$15.00
Thumb Safety	\$10.00
Thumb Safety, Extended	\$15.00
Trigger, New Match with Adjustable Stop	
Aluminum, with Allen Wrench	\$10.00
Blue, with Allen Wrench	\$10.00
Stainless, with Allen Wrench	\$10.00

M&A PARTS INC.

527 Telser Road
Lake Zurich, IL 60047
Tel: 847-550-8246
Fax: 847-550-0654
www.m-aparts.com

**WE SET THE STANDARD, OUR COMPETITORS WILL FOLLOW!
ALL OUR PARTS ARE MADE IN THE U.S.A. - AND WE'RE PROUD OF IT!**

M&A LOGO GEAR



M&A PARTS Sweatshirt

Available in Gray or Blue
Large or X-Large **\$21.00**
XX-Large **\$25.00**



M&A PARTS T-Shirt

Available in Blue, Black or Gray
Medium, Large or X-Large **\$10.00**
XX-Large **\$14.00**



**M&A PARTS
Can Cooler
\$2.00**

**M&A PARTS
Flying Disc
\$2.00**

